

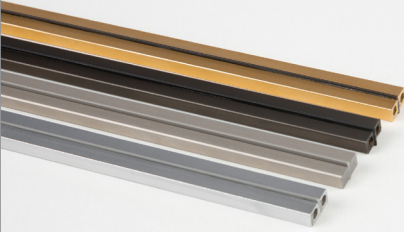

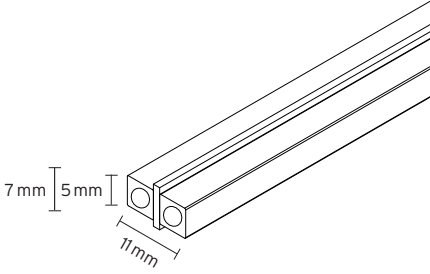

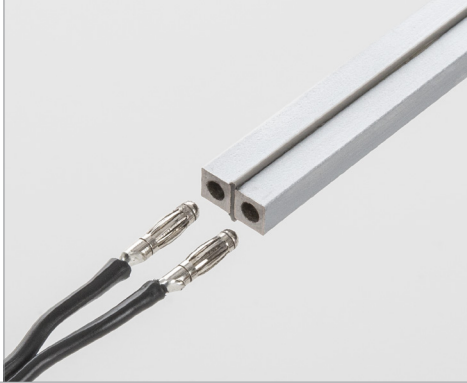

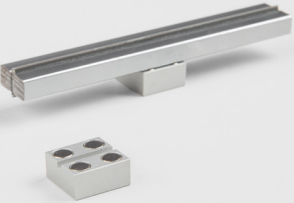
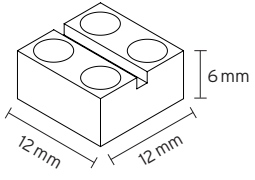

## Accessories // Magnetic Tracks

<b>magnetic track</b>		
	<ul style="list-style-type: none"> <li>- material: steel</li> <li>- colours: black, silver, gold, champagne</li> <li>- max. profile length 2,000 mm, from 2,000 mm with connector</li> <li>- electrical connection on one or both sides</li> <li>- power input: 12V DC constant voltage</li>   <li>- up to 10 spotlights per meter (max. load: 50W/2 meters)</li> </ul>	
<b>power supply</b>		
	<ul style="list-style-type: none"> <li>- power supply for magnetic track</li> <li>- colour: black</li> <li>- cable: standard length 3 m, cross section 0.5 mm<sup>2</sup> (other lengths on request), pre-assembled with banana plug</li> </ul>	<p style="text-align: right;">part number: A500023</p> 
<b>mounting part asymmetric, screw on</b>		
	<ul style="list-style-type: none"> <li>- material: aluminum</li> <li>- colour: anodised matte in black, silver, gold, champagne</li> <li>- attachment to wood: with countersunk screw for wood</li> <li>- attachment to metal: with countersunk screw for metal (M4)</li> <li>- both sides mountable</li>   <li>- recommended number per meter: 3</li> <li>- track secured with locking screw (M3x4)</li> </ul>	<p style="text-align: right;">part number: A300068</p> 
<b>mounting part mini, glue on</b>		
	<ul style="list-style-type: none"> <li>- material: aluminum</li> <li>- colour: anodised matte in black, silver, gold, champagne</li> <li>- attachment: glue on (special construction adhesive)</li>   <li>- recommended number per meter: 4</li> </ul>	<p style="text-align: right;">part number: A300069</p> 

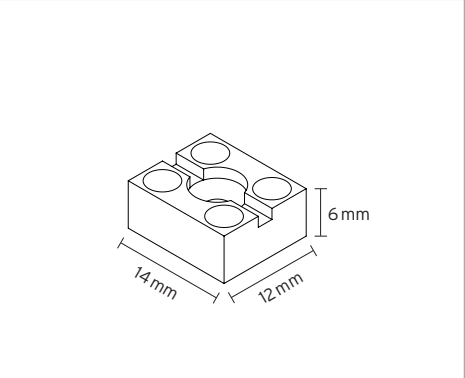
mounting part mini, screw on		part number: A300070
	<ul style="list-style-type: none"> <li>- material: aluminum</li> <li>- colour: anodised matte in black, silver, gold, champagne</li> <li>- attachment to wood: with countersunk screw for wood</li> <li>- attachment to metal: with countersunk screw for metal (M3)</li> </ul> <p>- recommended number per meter: 4</p>	

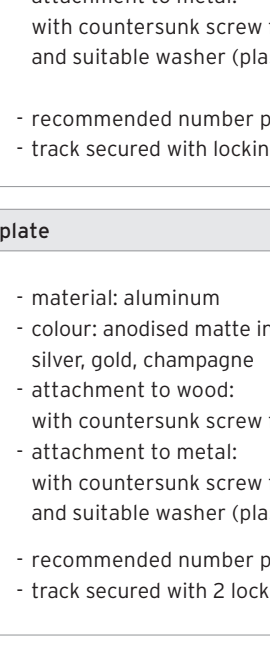
mounting part symmetric, glue on		part number: A300071
	<ul style="list-style-type: none"> <li>- material: aluminum</li> <li>- colour: anodised matte in black, silver, gold, champagne</li> <li>- attachment: glue on (special construction adhesive)</li> </ul> <p>- recommended number per meter: 3</p> <p>- track secured with locking screw (M3x4)</p>	

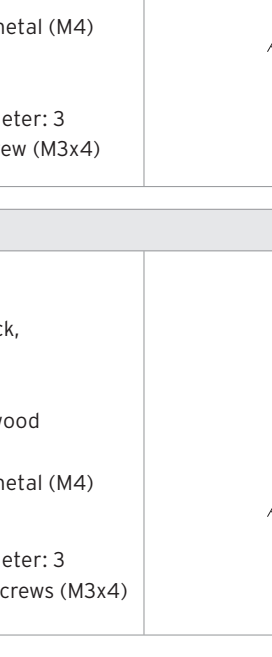
mounting part symmetric, screw on		part number: A300072
	<ul style="list-style-type: none"> <li>- material: aluminum</li> <li>- colour: anodised matte in black, silver, gold, champagne</li> <li>- attachment to wood: with countersunk screw for wood</li> <li>- attachment to metal: with countersunk screw for metal (M4) and suitable washer (plastic)</li> </ul> <p>- recommended number per meter: 3</p> <p>- track secured with locking screw (M3x4)</p>	

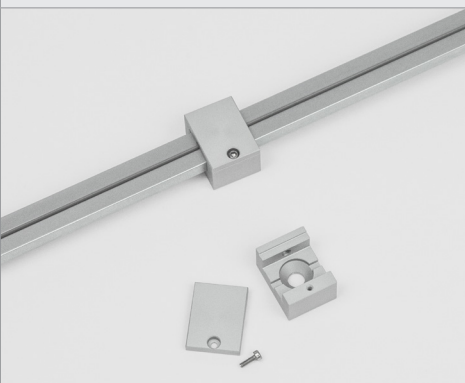
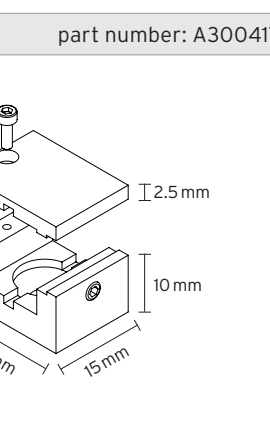
mounting part symmetric, screw on with lock plate		part number: A300417
	<ul style="list-style-type: none"> <li>- material: aluminum</li> <li>- colour: anodised matte in black, silver, gold, champagne</li> <li>- attachment to wood: with countersunk screw for wood</li> <li>- attachment to metal: with countersunk screw for metal (M4) and suitable washer (plastic)</li> </ul> <p>- recommended number per meter: 3</p> <p>- track secured with 2 locking screws (M3x4)</p>	

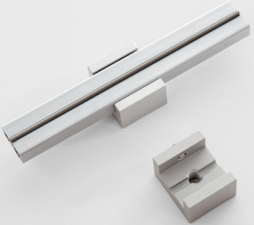
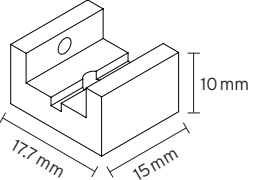
mounting part symmetric, with internal thread		part number: A300073
	<ul style="list-style-type: none"> <li>- material: aluminum</li> <li>- colour: anodised matte in black, silver, gold, champagne</li> <li>- attachment to wood or metal: with wood or metal screw</li> <li>- suitable for internal threads (M4)</li> </ul> <ul style="list-style-type: none"> <li>- recommended number per meter: 3</li> <li>- track secured with locking screw (M3x4)</li> </ul>	

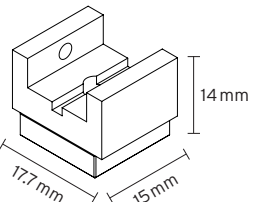
mounting part symmetric, magnetic		part number: A300073M
	<ul style="list-style-type: none"> <li>- material: aluminum</li> <li>- colour: anodised matte in black, silver, gold, champagne</li> <li>- attachment to magnetic surfaces</li> </ul> <ul style="list-style-type: none"> <li>- recommended number per meter: 3</li> <li>- track secured with locking screw (M3x4)</li> </ul>	

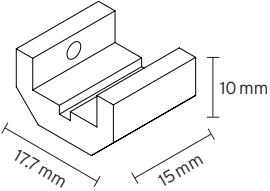
mounting part corner symmetric, glue on		on request - part number: A300077
	<ul style="list-style-type: none"> <li>- material: aluminum</li> <li>- colour: anodised matte in black, silver, gold, champagne</li> <li>- attachment: glue on (special construction adhesive)</li> </ul> <ul style="list-style-type: none"> <li>- recommended number per meter: 3</li> <li>- track secured with locking screw (M3x4)</li> </ul>	

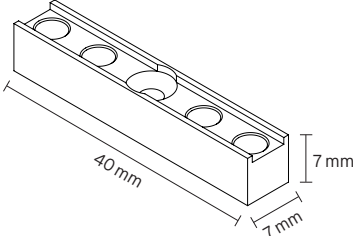
Befestigung mini 90° schraubbar		on request - part number: A300241
	<ul style="list-style-type: none"> <li>- material: aluminum</li> <li>- colour: anodised matte in black, silver, gold, champagne</li> <li>- attachment to wood: with countersunk screw for wood</li> <li>- attachment to metal: with countersunk screw for metal (M4)</li> </ul> <ul style="list-style-type: none"> <li>- recommended number per meter: 4</li> </ul>	

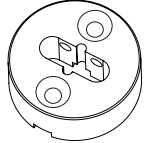
<p><b>Puck Ø 26 mm, POM, screw on</b></p>		<p>part number: A3000120-S</p>
	<ul style="list-style-type: none"> <li>- material: POM</li> <li>- colour: in black, grey</li> <li>- attachment to wood: with 2 countersunk screws for wood</li> <li>- attachment to metal: with 2 countersunk screws for metal (M3)</li> </ul> <p>- track secured with 2 locking screws (M3x4)</p>	 <p>Ø 26 mm / height 10 mm</p>

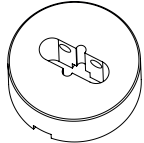
<p><b>Puck Ø 26 mm, POM, magnetic</b></p>		<p>part number: A3000120-M</p>
	<ul style="list-style-type: none"> <li>- material: POM</li> <li>- colour: in black, grey</li> <li>- attachment to magnetic surfaces</li> </ul> <p>- track secured with 2 locking screws (M3x4)</p>	 <p>Ø 26 mm / height 10 mm</p>

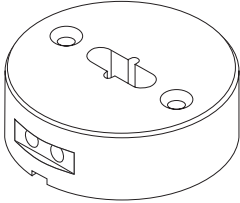
<p><b>Puck Ø 45 mm, POM, screw on</b></p>		<p>part number: A3000121-S</p>
	<ul style="list-style-type: none"> <li>- material: POM</li> <li>- colour: in black, grey</li> <li>- attachment to wood: with 2 countersunk screws for wood</li> <li>- attachment to metal: with 2 countersunk screws for metal (M3)</li> </ul> <p>- track secured with 2 locking screws (M3x4)</p>	 <p>Ø 45 mm / height 16 mm</p>

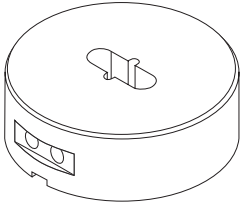
<p><b>Puck Ø 45 mm, POM, magnetic</b></p>		<p>part number: A3000121-M</p>
	<ul style="list-style-type: none"> <li>- material: POM</li> <li>- colour: in black, grey</li> <li>- attachment to magnetic surfaces</li> </ul> <p>- track secured with 2 locking screws (M3x4)</p>	 <p>Ø 45 mm / height 16 mm</p>

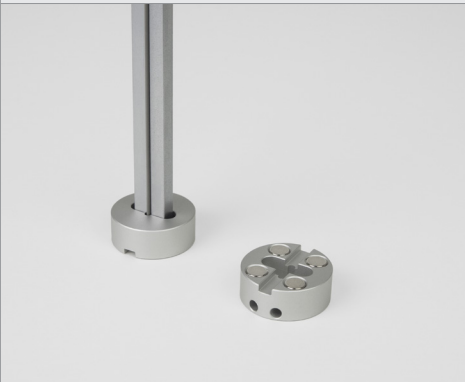
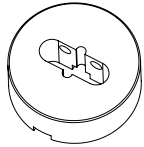
<b>Puck Ø 26 mm, aluminum, magnetic</b>		part number: A300079-M
	<ul style="list-style-type: none"> <li>- material: aluminum</li> <li>- colour: anodised matte in black, silver, gold, champagne</li> <li>- attachment to magnetic surfaces</li> </ul>	 <p>Ø 26 mm / height 10 mm</p>
<ul style="list-style-type: none"> <li>- track secured with 2 locking screws (M3x4)</li> </ul>		

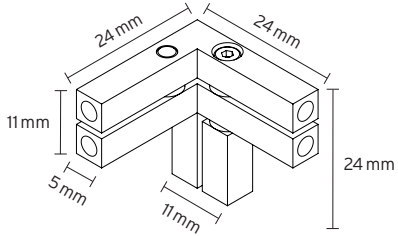
<b>Y-connector</b>		part number: A300396
	<ul style="list-style-type: none"> <li>- material: aluminum</li> <li>- colour: anodised matte in black, silver, gold, champagne</li> <li>- 2 variants (mirrored)</li> <li>- mounting: banana plugs</li> </ul>	

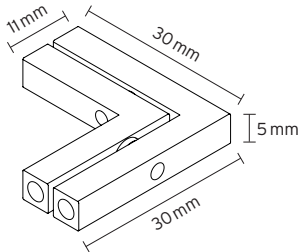
<b>corner connector horizontal</b>		part number: A300403
	<ul style="list-style-type: none"> <li>- material: aluminum</li> <li>- colour: anodised matte in black, silver, gold, champagne</li> <li>- mounting: banana plugs</li> </ul>	

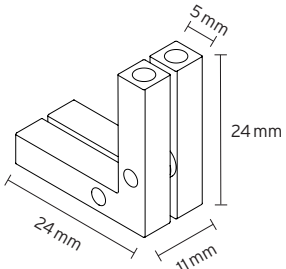

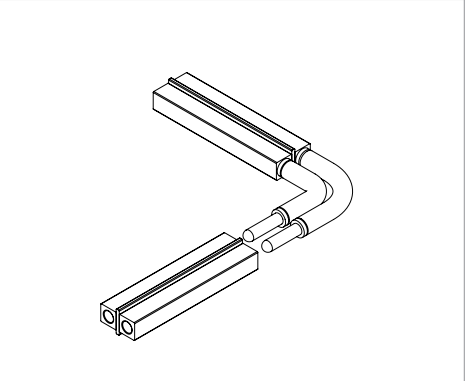
<b>corner connector vertical, 15 mm</b>		part number: A300404
	<ul style="list-style-type: none"> <li>- material: aluminum</li> <li>- colour: anodised matte in black, silver, gold, champagne</li> <li>- mounting: banana plugs</li> </ul>	

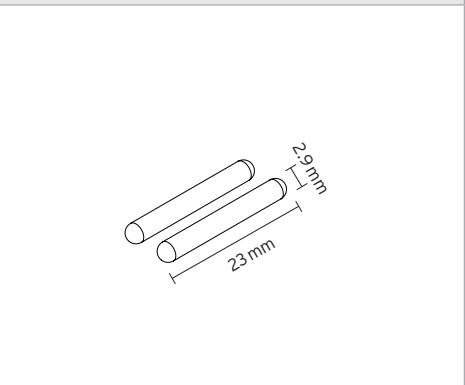
<b>corner connector flexible</b>		part number: A500501
	<ul style="list-style-type: none"> <li>- double-sided plug contact with double-core cable, soldered</li> <li>- cable cross-section 2 x 0.5 mm<sup>2</sup></li> <li>- standard length 27 mm and 37 mm (length adjustable on request)</li> </ul>	

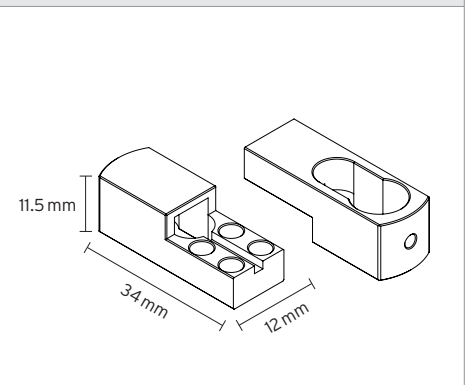
<b>connector straight</b>		part number: A301860
	<ul style="list-style-type: none"> <li>- double banana plugs</li> <li>- double-sided banana plug contact, recessed in the magnetic track</li> </ul>	

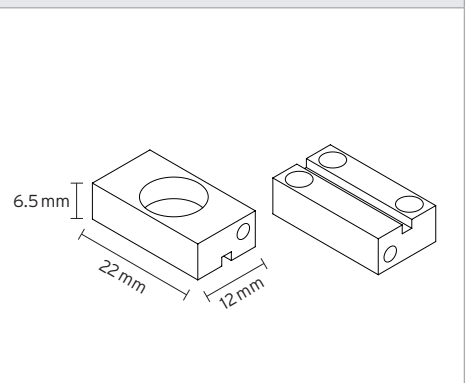
<b>adapter for showcase installation</b>		on request - part number: A300087
	<ul style="list-style-type: none"> <li>- material: aluminum</li> <li>- colour: anodised matte in black, silver, gold, champagne</li> <li>- adapter incl. support tube (Ø 10 mm) and mounting set (flange and nut)</li> <li>- max. length of magnetic track 1.20 m (without central support)</li> </ul>	

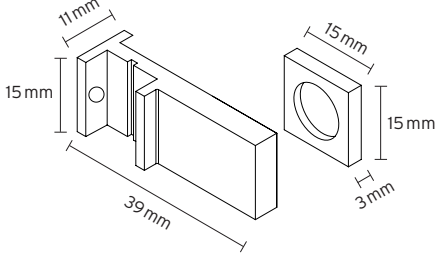
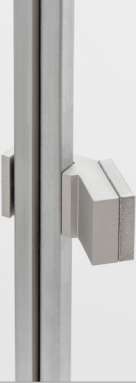
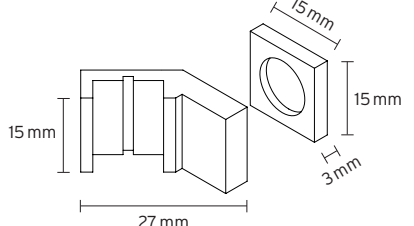
<b>central support for showcase installation</b>		on request - part number: A300088
	<ul style="list-style-type: none"> <li>- material: aluminum</li> <li>- colour: anodised matte in black, silver, gold, champagne</li> <li>- holder incl. support tube (Ø 10 mm) and mounting set (flange and nut)</li> <li>- recommended from a length of 1.20 m to prevent the magnetic track from sagging</li> </ul>	

<p><b>mounting part glass</b></p>	<p><b>on request</b> - part number: A300089</p>
	<ul style="list-style-type: none"> <li>- material: aluminum</li> <li>- colour: anodised matte in black, silver, gold, champagne</li> <li>- holder in a set with steel plate</li> <li>- attachment to glass: glue the steel plate to the glass and attach the holder to it magnetically</li>   <li>- recommended number per meter: 2</li> <li>- track secured with locking screw (M3x4)</li> </ul>
	
<p><b>mounting part glass 45°</b></p>	<p><b>on request</b> - part number: A300090</p>
	<ul style="list-style-type: none"> <li>- material: aluminum</li> <li>- colour: anodised matte in black, silver, gold, champagne</li> <li>- holder in a set with steel plate</li> <li>- attachment to glass: glue the steel plate to the glass and attach the holder to it magnetically</li>   <li>- recommended number per meter: 2</li> <li>- track secured with locking screw (M3x4)</li> </ul>
	
<p><b>glass shelf holder</b></p>	<p><b>on request</b> - part number: A300075</p>
	<ul style="list-style-type: none"> <li>- material: aluminum</li> <li>- colour: anodised matte in black, silver, gold, champagne</li> <li>- attachment to magnetic track: with 2 screws (M3) incl.</li> </ul>
